

PS-10F/10FB

PS-10F: Silver Type
US Model
AEP Model
E Model

PS-10FB: Black Type
AEP Model



PS-10F

STEREO TURNTABLE SYSTEM

SPECIFICATIONS

GENERAL

Power Requirements: 120 V ac, 60 Hz (US model)
220 V ac (or 240 V ac adjustable by authorized Sony Personnel), 50/60 Hz (AEP model)
110, 120, 220 or 240 V ac adjustable, 50/60 Hz (E model)

Power Consumption: 6 W

Dimensions: Approx. 430 (w) x 125 (h) x 365 (d) mm
17 (w) x 5 (h) x 14 $\frac{3}{8}$ (d) inches
with the dust cover closed
Approx. 430 (w) x 355 (h) x 365 (d) mm
17 (w) x 14 (h) x 14 $\frac{3}{8}$ (d) inches
with the dust cover fully opened
including projecting parts and controls

Weight: Approx. 6.5 kg, 14 lb 5 oz (net)

TURNTABLE

Platter: 31.4 cm (12 $\frac{3}{8}$ inches) dia, aluminum-alloy diecast

Motor: Dc servo-controlled motor (brush-less and slotless)

Drive System: Direct drive, crystal controlled

Speed: 33 $\frac{1}{3}$, 45 rpm

Wow and Flutter: ± 0.045 % (DIN)
0.03 % (WRMS)

S/N Ratio: Better than 70 dB (DIN-B)

TONEARM

Type: Statically balanced, universal

Pivot to Stylus Length: 216.5 mm (8 $\frac{1}{2}$ inches)

Overhang: 16.5 mm ($\frac{2}{3}$ inch)

Tracking-force Adjustment Range: 0 - 3 g

Shell Weight: 7.5 g

Cartridge Weight Range: 4.5 - 9.5 g

- Continued on page 2 -

SAFETY-RELATED COMPONENT WARNING!!

COMPONENTS IDENTIFIED BY SHADING AND MARK  ON THE SCHEMATIC DIAGRAMS, EXPLODED VIEWS AND IN THE PARTS LIST ARE CRITICAL TO SAFE OPERATION. REPLACE THESE COMPONENTS WITH SONY PARTS WHOSE PART NUMBERS APPEAR AS SHOWN IN THIS MANUAL OR IN SUPPLEMENTS PUBLISHED BY SONY.

SONY[®]
SERVICE MANUAL

CARTRIDGE VL-34G (US, AEP model)

Type: Moving-magnet
Frequency Response: 10 Hz — 30 kHz
Channel Separation: Better than 25 dB at 1 kHz
Output Voltage: 3 mV at 1 kHz, 5 cm/sec, 45°
Tracking Force: 1.5 — 2.5 g (2 g recommended)
Stylus: Sony ND-134G (Conical 0.6 mil diamond)
Weight: 5.5 g

CARTRIDGE VL-15G (E model)

Type: Moving magnet
Frequency Response: 10 Hz — 30 kHz
Channel Separation: Better than 25 dB at 1 kHz
Output Voltage: 4 mV at 1 kHz, 5 cm/sec, 45°
Tracking Force: 1.2 — 2.5 g (1.7 g recommended)
Stylus: Sony ND-15G (Conical 0.6 mil diamond)
Weight: 5.2 g

• MODEL IDENTIFICATIONS — Specification Label —

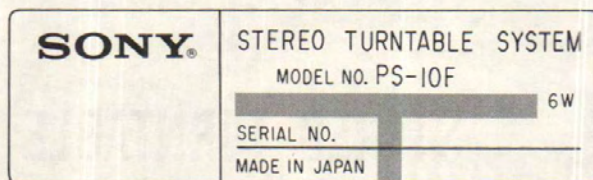

PS-10FB : AEP model only

AC 220V ~ 50Hz : AEP model
AC 120V 60Hz : US model
AC 110, 120, 220, 240V ~ 50/60Hz : E model

SECTION 1 OUTLINE

1-1. CIRCUIT DESCRIPTION

1). Hall Motor

This set is equipped with the newly developed BSL (brush and slotless) dc servo motor, which has the following major advantages.—

1. Extremely uniform torque.
2. All-electronic switching (no mechanical contacts used at all), resulting in very little noise.
3. Extremely stable performance, and long operational life.

2). Hall Element

The magnetic field strength is converted into electrical signals by employing the Hall Effect*.

*The Hall Effect: When current (I) flows through a substance, and magnetic field (B) is applied at right angles to the direction of the current flow, a potential difference (V) will be generated in a direction at right angles to both the current and the magnetic field.

The potential is proportional to amounts of the current and a strength of the magnetic field.

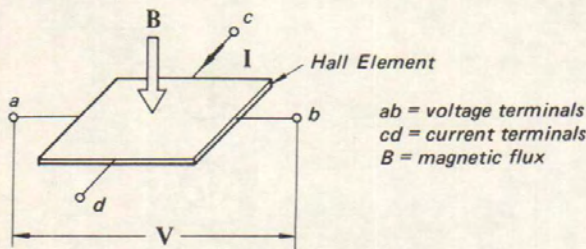

Fig. 1

When the N pole approaches.

When the S pole approaches.

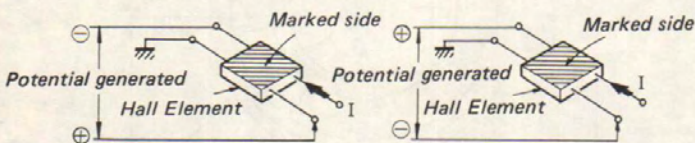

Fig. 2

3). Motor Internal View (top view)

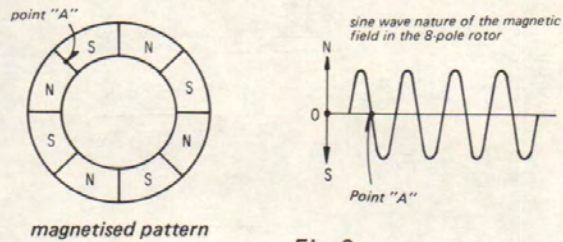
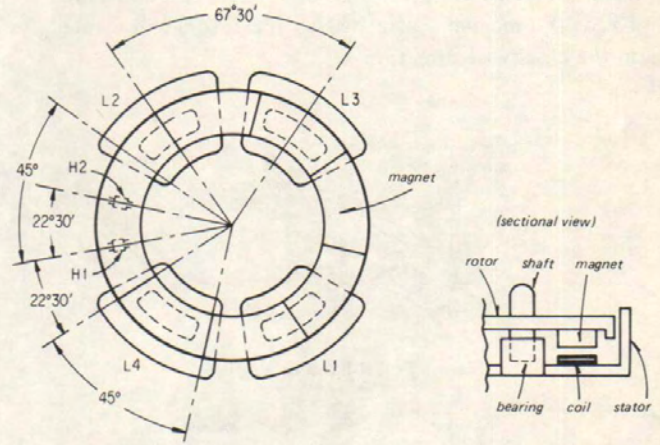
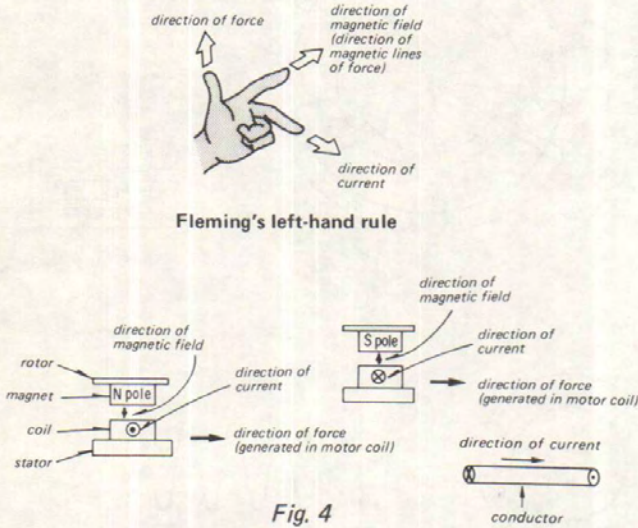

Fig. 3

- The motor coils L1 and L2 (L3 and L4) form a pair, connected in series.
- The reason for positioning two Hall elements H1 and H2 at an angle of $22^{\circ}30'$ from each other is to displace the electrical phase angle by 90° , thereby rotating the rotor in a 2-phase action.
- For the same reason, the positions of the coil pairs are set at an angle of $67^{\circ}30'$.
- The center angle of the coil is 45° so that the coil faces the magnets of which 8 poles are positioned every 45° apart.
- Hall elements and motor coils have been set apart at an angle of $22^{\circ}30'$ so that the peak of an N or S pole magnetic field will cut across the center of a motor coil at the same time that the magnetic field peak of the preceding or following S or N pole cuts across a Hall element.

4). Generation of Rotational Force (See Fig. 4)

According to the Fleming's left-hand rule, the force generated in the motor coils will be in the counterclockwise direction, but since the coils are fixed, the magnets (attached to the rotor) will rotate in the clockwise direction.



When an N pole corresponds to the Hall element H1 (shown in the Fig. 5), a positive voltage is generated in H1. This voltage is then amplified by IC401-A, and applied to Q401.

When Q401 is turned on, B+ voltage is applied to L1 and L2. The current flowing through L1 and L2, and the magnetic field produce an electro-magnetic force which spins the rotor in the direction of the arrow as shown in Fig. 5.

When an N pole corresponds to the Hall element H2 as shown in Fig. 5, current flows through L3 and L4, thereby generating the same electro-magnetic force to continue the spinning of the rotor.

When an S pole corresponds to the Hall element H1 (shown in Fig. 6), a negative voltage is generated in H1. This voltage is then amplified by IC401-A, and applied to Q402.

When Q402 is turned on, B- voltage is applied to L1 and L2. The current flowing through L1 and L2, and the magnetic field produce an electro-magnetic force which spins the rotor in the direction of the arrow as shown in Fig. 6.

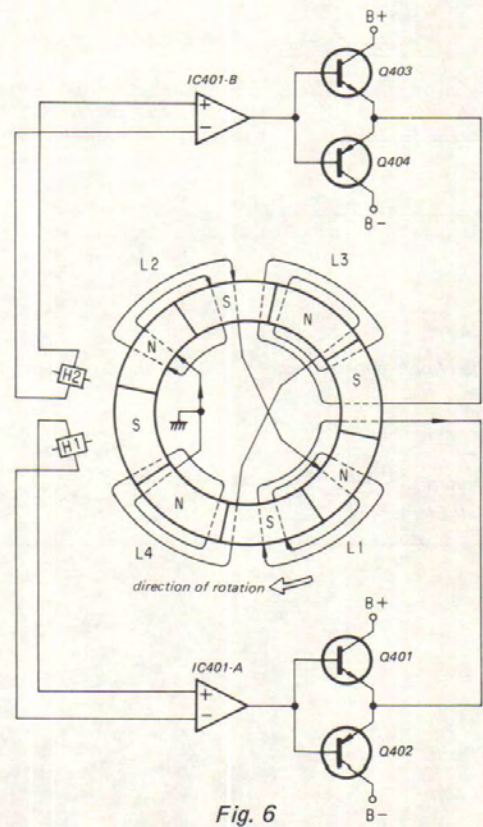
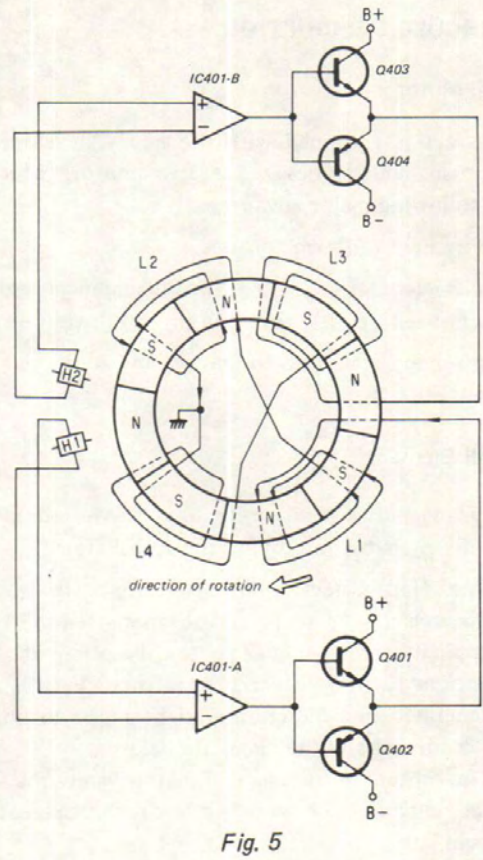

When an S pole corresponds to the Hall element H2, current flows through L3 and L4, thereby generating the same electro-magnetic force to continue the spinning of the rotor.

Hence, N and S poles are repeatedly positioned oppositely to the Hall elements H1 and H2 every $22^{\circ}30'$ of a rotation, thereby generating the voltages in these elements and resulting in the production of a current in the motor coils, and subsequent rotation of the motor.

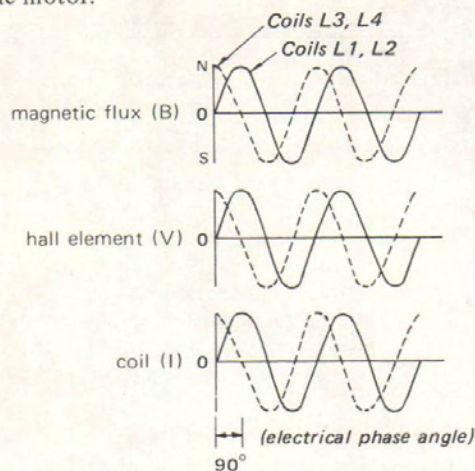

Fig. 7

5). Rotational Force

The rotational force (torque F) varies directly with the strength of the magnetic field (B) cutting across the coils, and the amount of current (I) flowing through the coils.

That is, $F = B \cdot I$

But since the magnetic field produced by the magnets of the rotor varies in accordance with a sine wave relation with the angle of rotation, and the pairs of motor coils are arranged 90° out of phase each other, the combined torque will be constant.

6). Constant Speed Rotation

In order to maintain constant turntable speed, this model features a magnetic-disc detection system in the speed-detector stage, and a crystal oscillator in the phase control stage of a crystal-locked servo system.

Changes in rotational speed of the turntable are detected by the speed-detecting head fixed on the frame. (S and N magnets are coated around the outer rim of the turntable platter with a very high degree of precision.) The reference standard frequencies detected by this head are 284 Hz at 33 rpm, and 384 Hz at 45 rpm. Any changes in frequency detected by this head are converted into voltage signals, and fed to the servo amplifier.

In addition, the phase of the frequency signal from the speed detection head is compared with the reference phase of the crystal oscillator frequency. Any difference in phase is also converted into a voltage signal, and fed to the servo amplifier, thereby ensuring accurate turntable rotational speed.

Since motor speed is determined by the amount of current flowing through the motor (that is, through the motor coils), motor speed may be conveniently changed by simply changing the flow of current through the Hall elements. In other words, if motor speed tends to deviate from the reference standard value due to external influences, the constant speed value may be maintained by simply varying the amount of current flowing through the Hall elements in proportion to the amount of deviation in turntable speed.

7). Phase Control

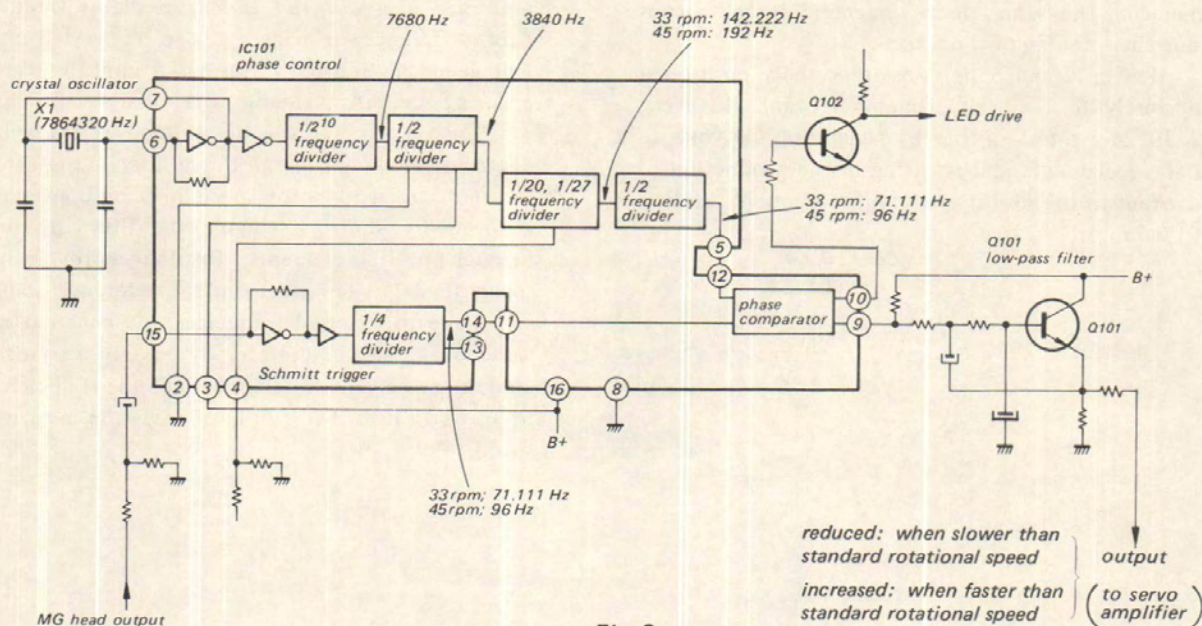

Fig. 8

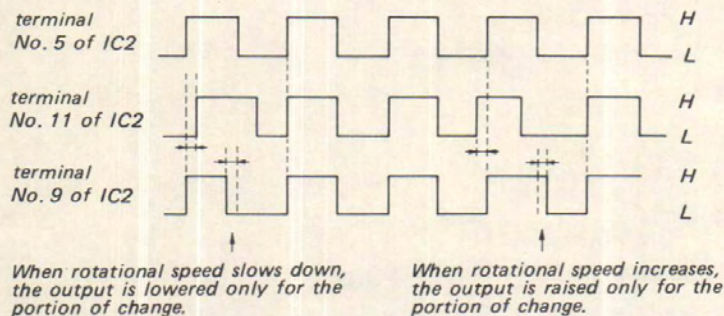

Fig. 9

8). Servo Control

If for any reason, motor speed decreases or increases, even by the slightest degree, the servo control mechanism is activated to correct the deviation, and returns the speed to the reference standard value.

1. If the motor speed slightly decreases, the frequency of the MG head output signal decreases. This signal is applied to the phase control circuit (IC101) for phase comparison. The resultant output, of decreased voltage level, is then sent to the servo control. And since the base voltage of Q204 is reduced, the emitter voltage (reference voltage) of Q203 also decreases, resulting in the width of the Q203 collector output pulse being widened.
2. The dc output voltage from the low-pass filter consequently decreases, thereby increasing motor speed back to the original standard value.
3. If, on the other hand, motor speed is increased by some external influence, the servo control mechanism reduces speed in the opposite manner of that described above.

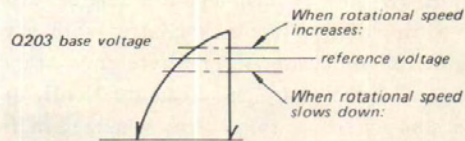
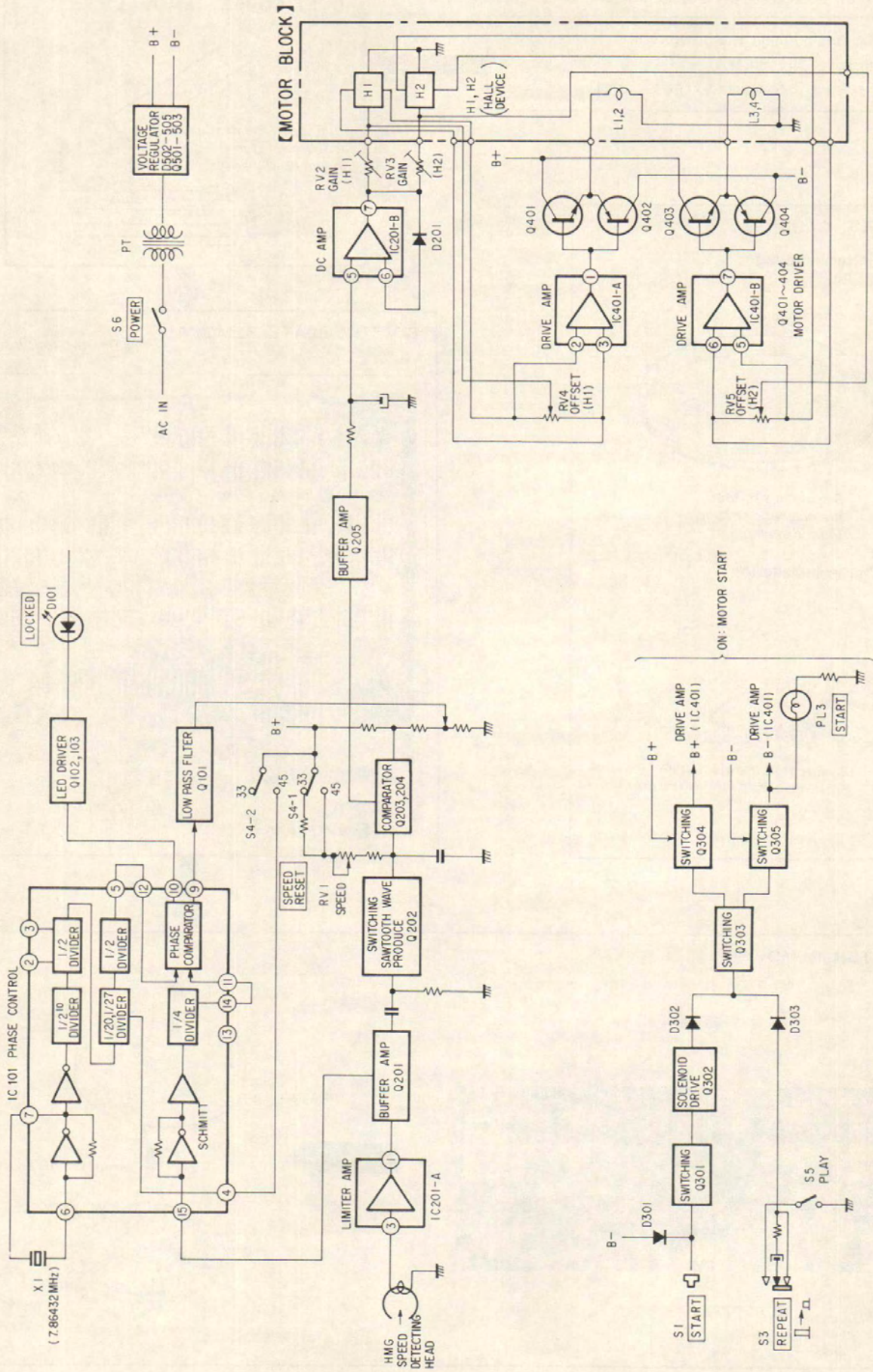

Fig. 10

1-2. BLOCK DIAGRAM



SECTION 2
DISASSEMBLY

Note: Follow the disassembly procedure in the numerical order given.

- Do not connect the power cord.
- Remove the platter.
- Secure the tonearm to the arm rest.

DUST COVER REMOVAL

Fully open the dust cover and remove it in the direction shown by the arrow.

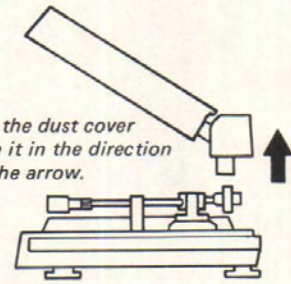

REPAIR CAUTION

- Platter handling

backside of platter

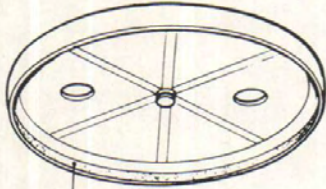

Be sure not to spoil the magnetic coating. (dark brown color)

- Platter installation

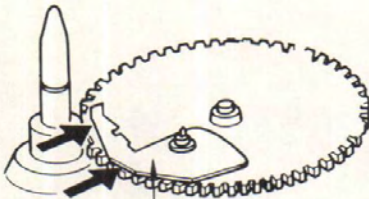

Be sure that the metal plate does not protrude outside the white gear.

BOTTOM PLATE REMOVAL

3 Remove four insulators.

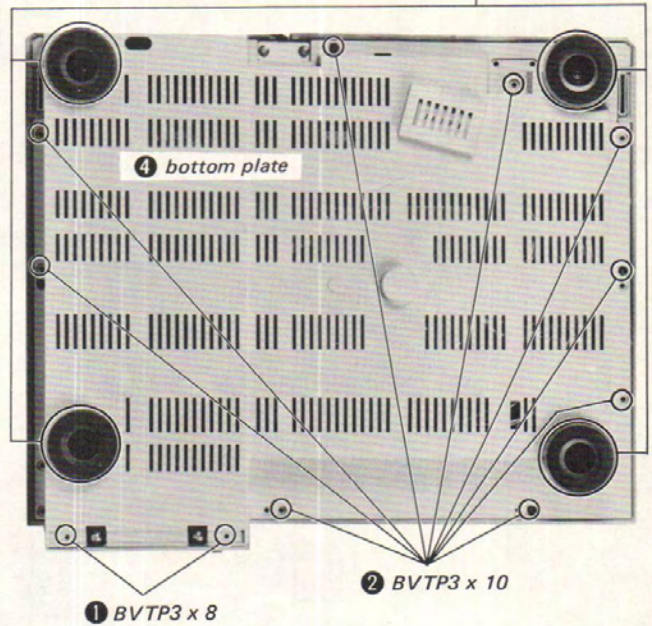

MOTOR REMOVAL

2 BVTP4 x 12

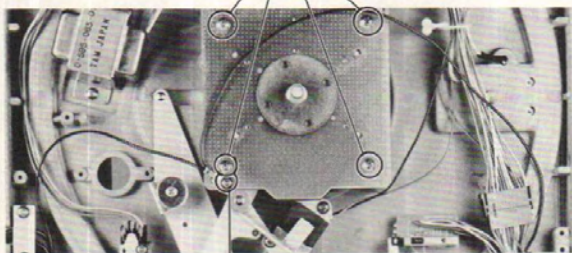

1 BVPT3 x 8

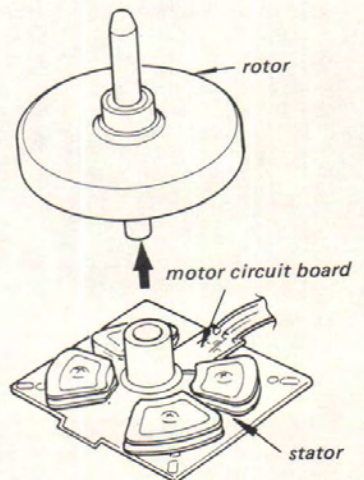

SECTION 3 ADJUSTMENTS

3-1. MECHANICAL ADJUSTMENTS

Brake Drum Position Adjustment

(POWER switch: OFF)

1. Secure the tonearm to the arm rest.
2. Loosen the set screw of the tonearm and set the brake shoe to the mark on the brake drum.
3. Tighten the set screw.

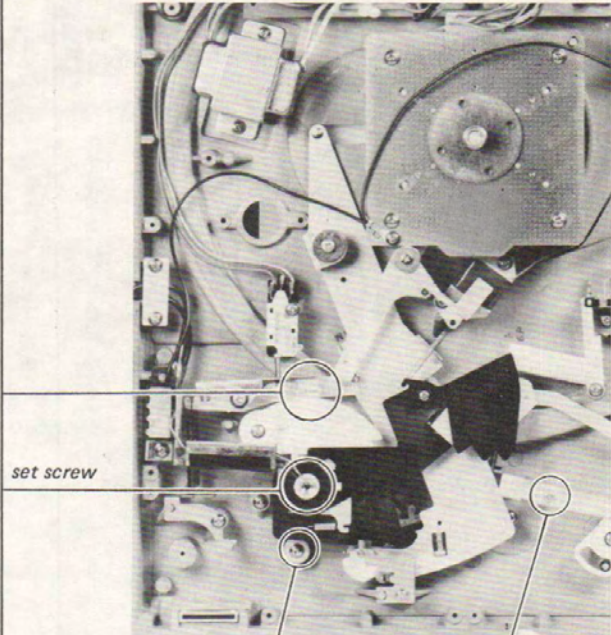
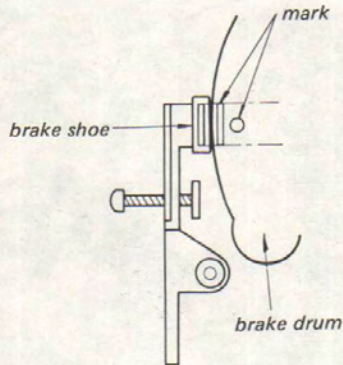

anti-skating
compensator
adjustment
(Do not adjust)

adjustment screw

Stylus Height Adjustment

(POWER switch: OFF)

1. Set the record size selector to MANUAL position.
2. Bring the tonearm above the record.
3. Lift the tonearm up by turning the cueing lever and make sure that the clearance between the stylus tip and the record is 4–10mm ($\frac{3}{8}$ – $\frac{1}{2}$ inches).
4. If necessary, loosen the adjustment screw and adjust the lifter height.

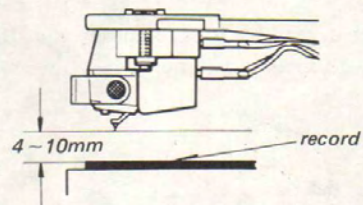

Adjustment screw	Stylus height
clockwise	up
counterclockwise	down

Brake Lever Position Adjustment

(POWER switch: OFF)

1. Rotate the drive gear by hand and set the drive gear to play position as shown below.

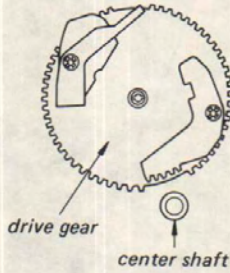

2. Turn the adjustment screw so that the clearance between the brake drum and the brake shoe is 1mm.

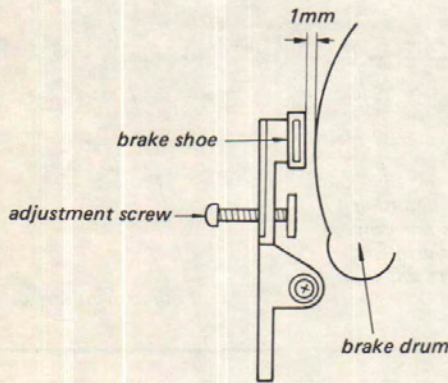

3. Rotate the drive gear by hand and set the drive gear to stop position as shown below.

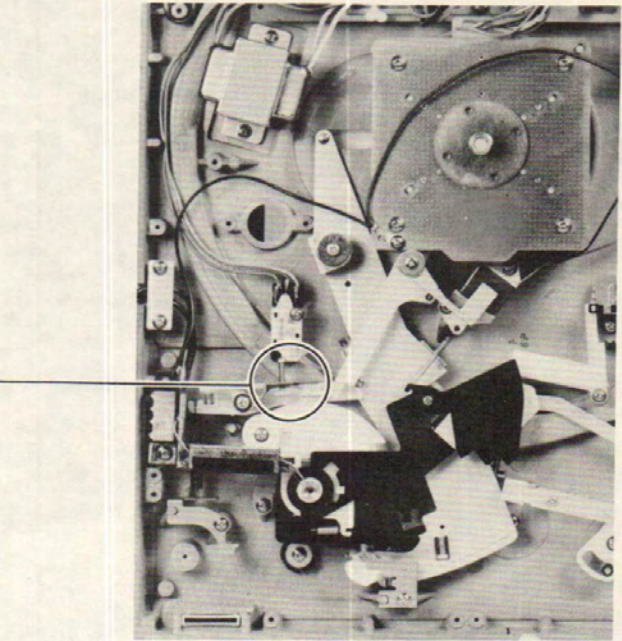
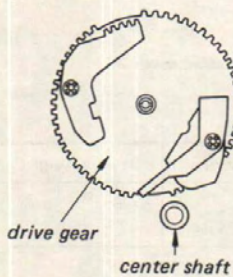

4. Make sure that the clearance between the brake shoe and portion (A) is 1mm.
5. If necessary, turn the adjustment screw so that the clearance is 1mm.

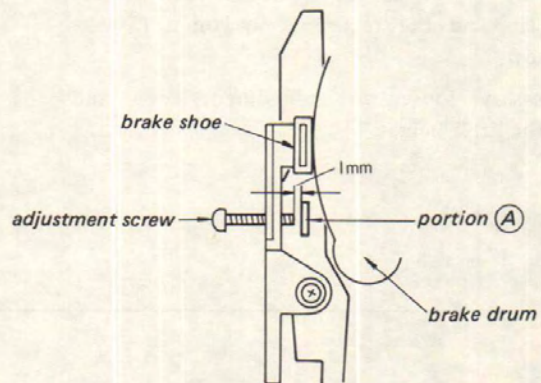

Automatic Return Position Adjustment

(POWER switch: OFF)

1. Remove the rubber mat and the platter.
2. Put the tonearm on the arm rest.
3. Turn the center shaft clockwise by hand and turn the drive gear one turn by engaging the center gear with the drive gear. Then place the drive gear in the disengaging position.
4. Push clutch (B) in the direction shown by the arrow and place clutch (A) and clutch (B) as shown below:

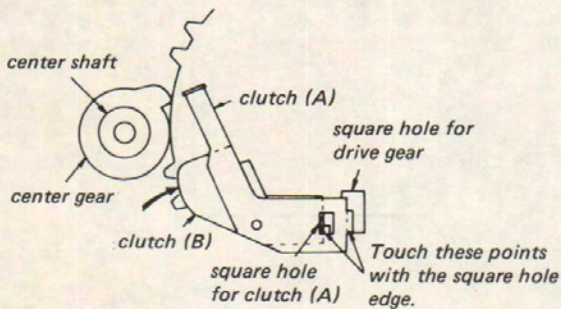

5. Put the return adjustment scale (part No. 9-911-814-01) on the center shaft.
6. Move the tonearm toward the center shaft by hand so that clutch (A) is positioned as shown below and confirm that the stylus is located on the hatched area of the return adjustment scale.

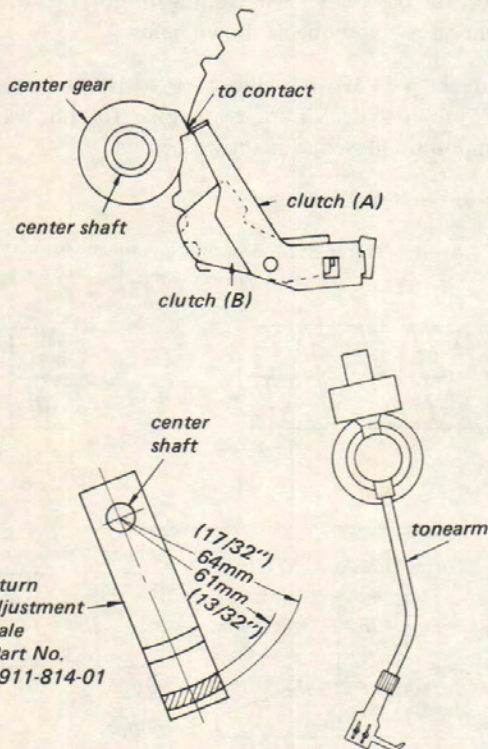

7. If necessary, adjust the adjustment screw.

Stylus Position	Adjustment Screw
outside of hatched area	clockwise
inside of hatched area	counterclockwise
on hatched area	correct

8. Set the test record (YFSC-16) on the turntable.
9. Make sure that the tonearm starts returning at count of 4-14.

adjustment screw

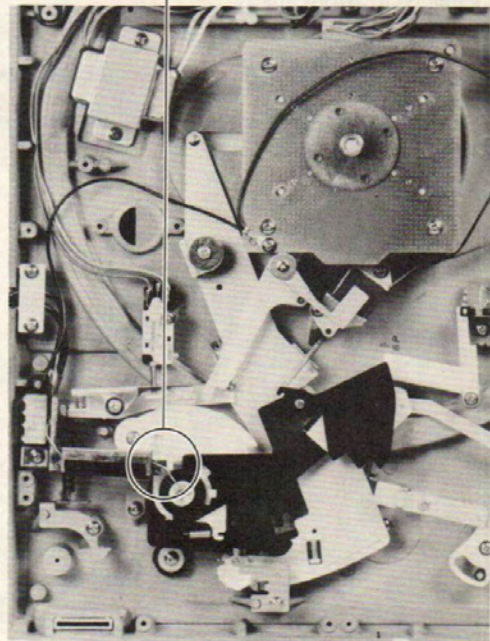

3-2. ELECTRICAL ADJUSTMENTS

Setting:

1. Set the SPEED switch to 33 position.
2. Disconnect the WHT/YEL lead wire and connect the regulated power supply as shown below.

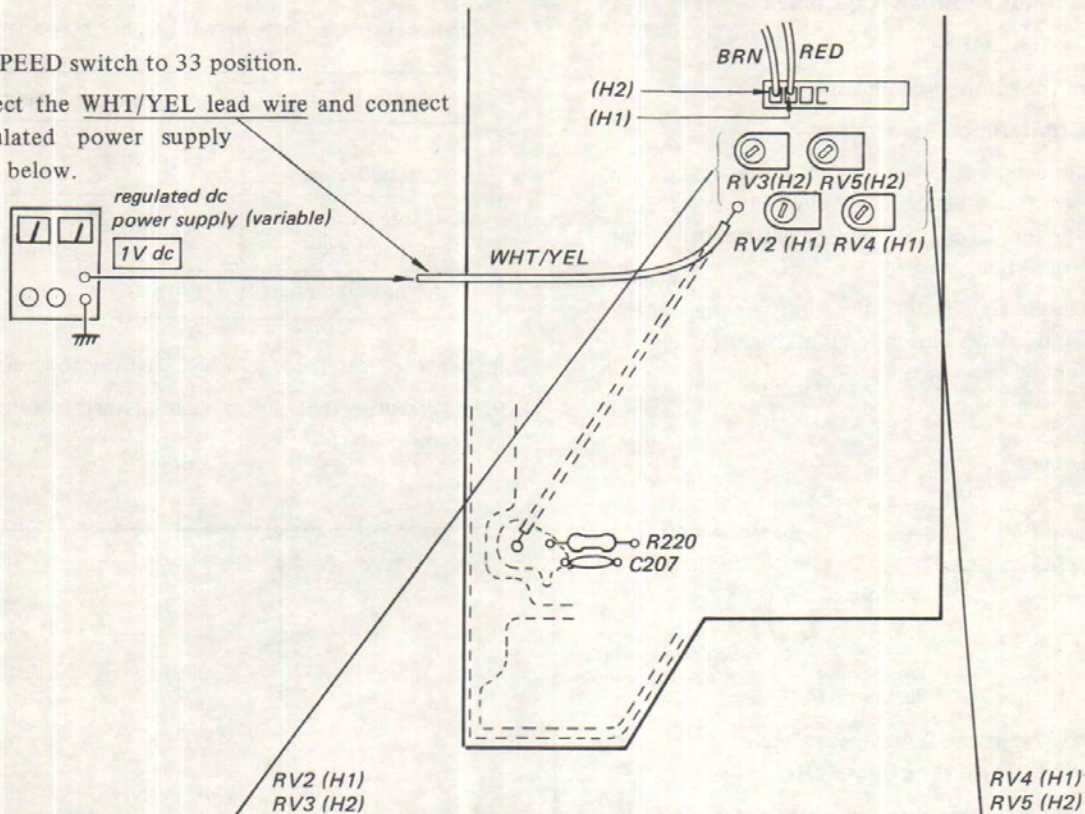

Hall Device Gain Adjustment

1. Connect an oscilloscope to H1 and adjust RV2 for the specified waveform on the oscilloscope.
2. Connect an oscilloscope to H2 and adjust RV3 for the specified waveform on the oscilloscope.

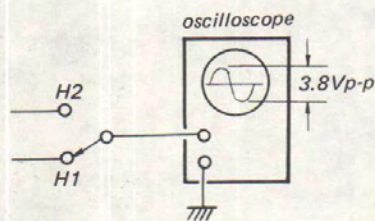

Waveform on Oscilloscope:

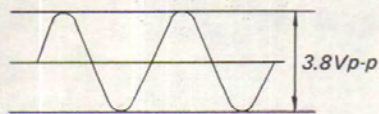

Reference:

The waveform on oscilloscope should be 3.8 times the power supply voltage (dc). If a dry battery (1V dc) is used instead of regulated power supply, the waveform on oscilloscope should be 3.8V ac.

Motor Amp Offset Adjustment

1. Connect VTVM or oscilloscope to H1 and adjust RV4 for 0V dc VTVM reading or for the waveform on oscilloscope as shown below.
2. Connect VTVM or oscilloscope to H2 and adjust RV5 for 0V dc VTVM reading or for the waveform on oscilloscope as shown below.

Waveform on Oscilloscope:

Note: Set the sweep time longer for easy waveform checking.

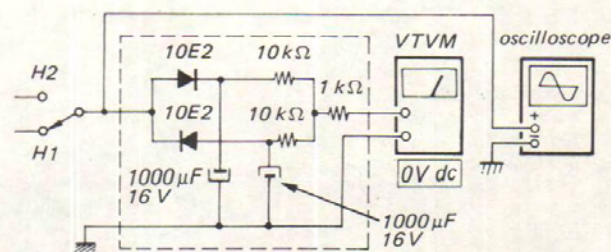
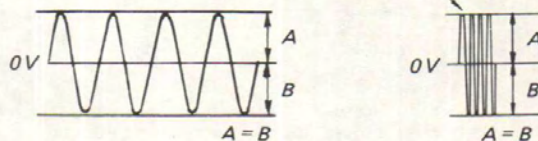

Turntable Speed Adjustment

1. Connect an oscilloscope to pin ⑨ of IC101 and adjust RV1 for the specified waveform on the oscilloscope.

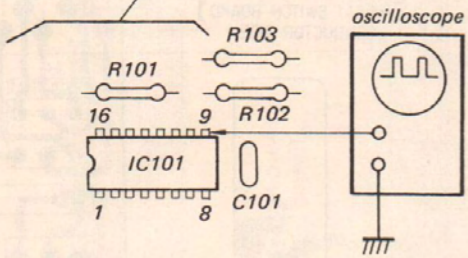
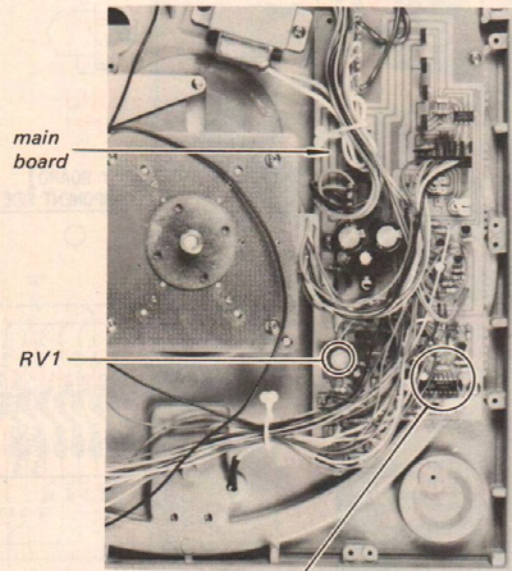

Waveform on Oscilloscope:

Correct:

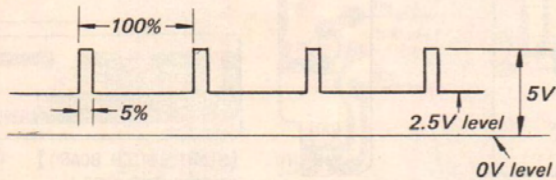

Incorrect:

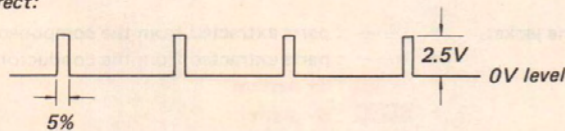

Speed Detecting Head Output Level Adjustment

Before this adjustment, set the speed detecting head on the head deck as shown below.

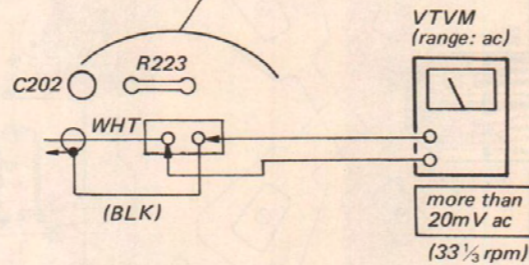
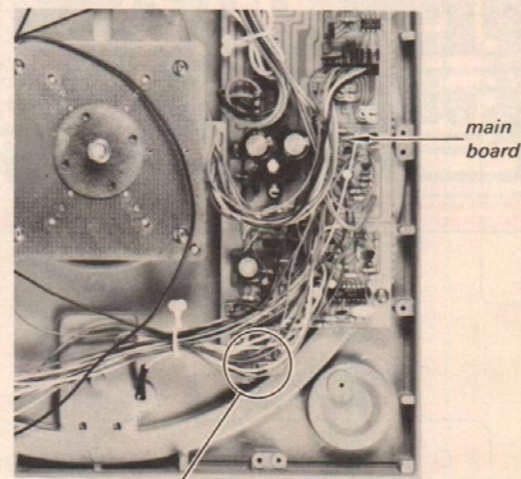
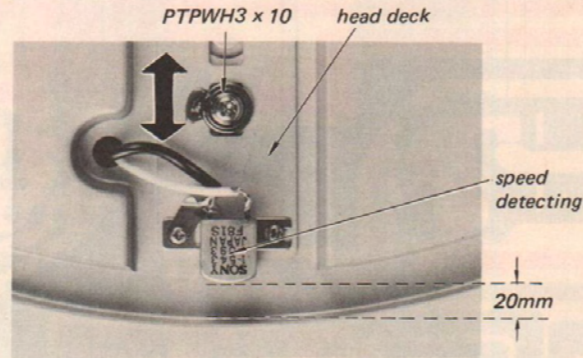

1. Adjust the position of the head deck so that the VTVM reading is more than 20mV ac at 33 1/3 rpm.
2. Make sure that the head does not touch the turntable and tighten the screws securely.

Note: The clearance between the magnet coated rim and the speed detecting head should be more than 0.3mm.

1/4 WATT CARBON RESISTORS (A) **Note:** Circled letter (A) is applicable to European models only.

Ω	Part No.	Ω	Part No.	Ω	Part No.	Ω	Part No.	Ω	Part No.	Ω	Part No.	Ω	Part No.
1.0	1-246-401-00	10	1-246-425-00	100	1-246-449-00	1.0k	1-246-473-00	10k	1-246-497-00	100k	1-246-521-00	1.0M	1-246-545-00
1.1	1-246-402-00	11	1-246-426-00	110	1-246-450-00	1.1k	1-246-474-00	11k	1-246-498-00	110k	1-246-522-00	1.1M	1-210-814-00
1.2	1-246-403-00	12	1-246-427-00	120	1-246-451-00	1.2k	1-246-475-00	12k	1-246-499-00	120k	1-246-523-00	1.2M	1-210-815-00
1.3	1-246-404-00	13	1-246-428-00	130	1-246-452-00	1.3k	1-246-476-00	13k	1-246-500-00	130k	1-246-524-00	1.3M	1-210-816-00
1.5	1-246-405-00	15	1-246-429-00	150	1-246-453-00	1.5k	1-246-477-00	15k	1-246-501-00	150k	1-246-525-00	1.5M	1-210-817-00
1.6	1-246-406-00	16	1-246-430-00	160	1-246-454-00	1.6k	1-246-478-00	16k	1-246-502-00	160k	1-246-526-00	1.6M	1-210-818-00
1.8	1-246-407-00	18	1-246-431-00	180	1-246-455-00	1.8k	1-246-479-00	18k	1-246-503-00	180k	1-246-527-00	1.8M	1-210-819-00
2.0	1-246-408-00	20	1-246-432-00	200	1-246-456-00	2.0k	1-246-480-00	20k	1-246-504-00	200k	1-246-528-00	2.0M	1-210-820-00
2.2	1-246-409-00	22	1-246-433-00	220	1-246-457-00	2.2k	1-246-481-00	22k	1-246-505-00	220k	1-246-529-00	2.2M	1-210-821-00
2.4	1-246-410-00	24	1-246-434-00	240	1-246-458-00	2.4k	1-246-482-00	24k	1-246-506-00	240k	1-246-530-00	2.4M	1-244-754-00
2.7	1-246-411-00	27	1-246-435-00	270	1-246-459-00	2.7k	1-246-483-00	27k	1-246-507-00	270k	1-246-531-00	2.7M	1-244-755-00
3.0	1-246-412-00	30	1-246-436-00	300	1-246-460-00	3.0k	1-246-484-00	30k	1-246-508-00	300k	1-246-532-00	3.0M	1-244-756-00
3.3	1-246-413-00	33	1-246-437-00	330	1-246-461-00	3.3k	1-246-485-00	33k	1-246-509-00	330k	1-246-533-00	3.3M	1-244-757-00
3.6	1-246-414-00	36	1-246-438-00	360	1-246-462-00	3.6k	1-246-486-00	36k	1-246-510-00	360k	1-246-534-00	3.6M	1-244-758-00
3.9	1-246-415-00	39	1-246-439-00	390	1-246-463-00	3.9k	1-246-487-00	39k	1-246-511-00	390k	1-246-535-00	3.9M	1-244-759-00
4.3	1-246-416-00	43	1-246-440-00	430	1-246-464-00	4.3k	1-246-488-00	43k	1-246-512-00	430k	1-246-536-00	4.3M	1-244-760-00
4.7	1-246-417-00	47	1-246-441-00	470	1-246-465-00	4.7k	1-246-489-00	47k	1-246-513-00	470k	1-246-537-00	4.7M	1-244-761-00
5.1	1-246-418-00	51	1-246-442-00	510	1-246-466-00	5.1k	1-246-490-00	51k	1-246-514-00	510k	1-246-538-00	5.1M	1-244-762-00
5.6	1-246-419-00	56	1-246-443-00	560	1-246-467-00	5.6k	1-246-491-00	56k	1-246-515-00	560k	1-246-539-00		
6.2	1-246-420-00	62	1-246-444-00	620	1-246-468-00	6.2k	1-246-492-00	62k	1-246-516-00	620k	1-246-540-00		
6.8	1-246-421-00	68	1-246-445-00	680	1-246-469-00	6.8k	1-246-493-00	68k	1-246-517-00	680k	1-246-541-00		
7.5	1-246-422-00	75	1-246-446-00	750	1-246-470-00	7.5k	1-246-494-00	75k	1-246-518-00	750k	1-246-542-00		
8.2	1-246-423-00	82	1-246-447-00	820	1-246-471-00	8.2k	1-246-495-00	82k	1-246-519-00	820k	1-246-543-00		
9.1	1-246-424-00	91	1-246-448-00	910	1-246-472-00	9.1k	1-246-496-00	91k	1-246-520-00	910k	1-246-544-00		

HARDWARE NOMENCLATURE

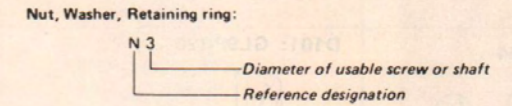
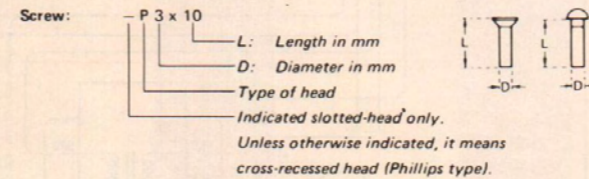

Reference Designation	Shape	Description	Remarks
SCREWS			
P		pan-head screw	binding-head (B) screw for replacement
PWH		pan-head screw with washer face	binding-head (B) screw and flat washer for replacement
PS PSP		pan-head screw with spring washer	binding-head (B) screw and spring washer for replacement
PSW PSPW		pan-head screw with spring and flat washers	binding-head (B) screw and spring and flat washers for replacement
R		round-head screw	binding-head (B) screw for replacement
K		flat-countersunk-head screw	
RK		oval-countersunk-head screw	
B		binding-head screw	
T		truss-head screw	binding-head (B) screw for replacement
F		flat-fillister-head screw	
RF		fillister-head screw	
BV		braizer-head screw	

Reference Designation	Shape	Description	Remarks
SELF-TAPPING SCREWS			
TA		self-tapping screw	ex: TA, P 3 x 10
PTP		pan-head self-tapping screw	binding-head self-tapping (TA, B) screw for replacement
PTPWH		pan-head self-tapping screw with washer face	binding-head self-tapping (TA, B) screw and flat washer for replacement
PTTWH		pan-head thread-rolling screw with washer face	binding-head (B) screw and flat washer for replacement
SET SCREWS			
SC		set screw	
SC		hexagon-socket set screw	ex: SC 2.6 x 4, hexagon socket
NUT			
N		nut	
WASHERS			
W		flat washer	
SW		spring washer	
LW		internal-tooth lock washer	ex: LW3, internal
LW		external-tooth lock washer	ex: LW3, external
RETAINING RINGS			
E		retaining ring	
G		grip-type retaining ring	

SECTION 4 DIAGRAMS

PS-10F/10FB PS-10F/10FB

4-1. MOUNTING DIAGRAMS — Conductor Side —

Replacement Semiconductors

For replacement, use semiconductors except in ().

IC101: MSM5811

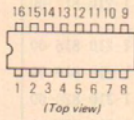

IC201, 401: μ PC4558C (μ PC4558)

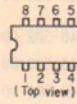

Q101-103
Q201-204
Q301, 303
Q305, 501

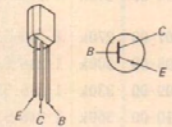

Q205, 302, 304: 2SA1027R (2SA733)

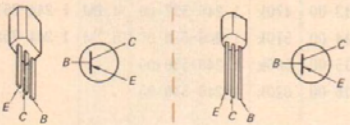

Q401, 403
Q502

Q402, 404: 2SB548

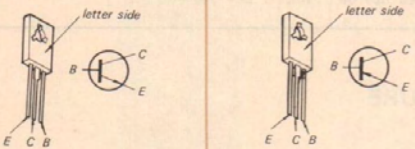

Q503: 2SB564

D101: GL9PR20

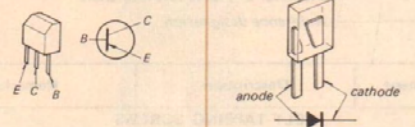

D201
D301-303

D502, 503: EQB01-13 (EQA01-13R)

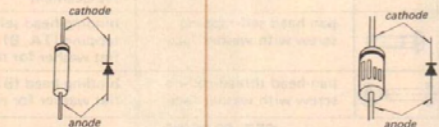

D504: S3VC40 (MI151)

D505: S3VC40R (MI151R)

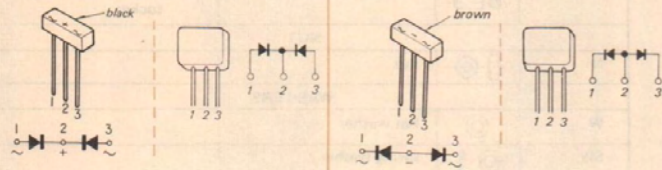

H1, 2: F1410



402	404	403	401	IC401	305	304	303	503, 502	502	301	204	205	103	202	IC101, 501	201, IC201	Q, IC
					505			503, 502		301					201	101	D
					504			302	303								

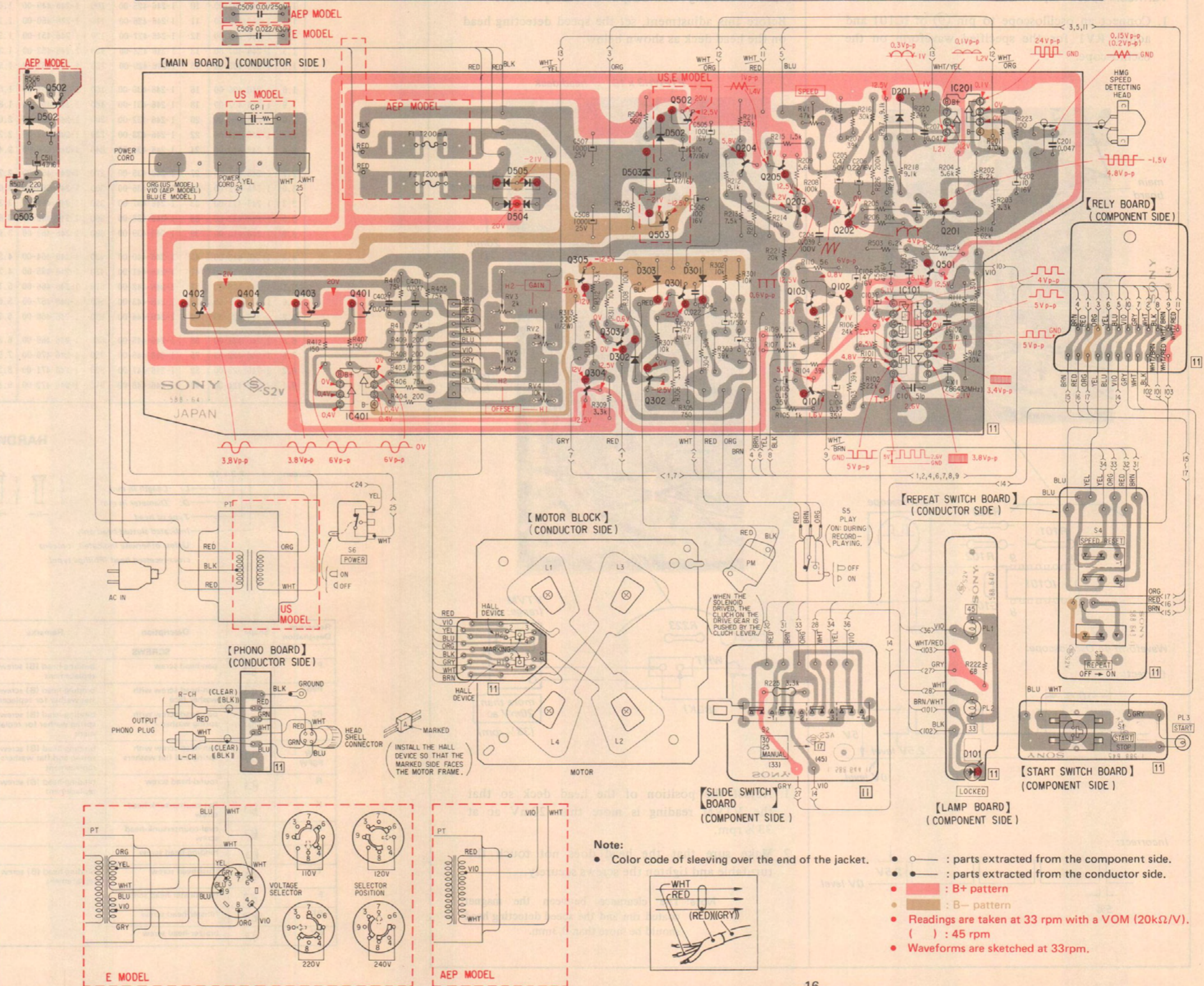

4-2. SCHEMATIC DIAGRAM

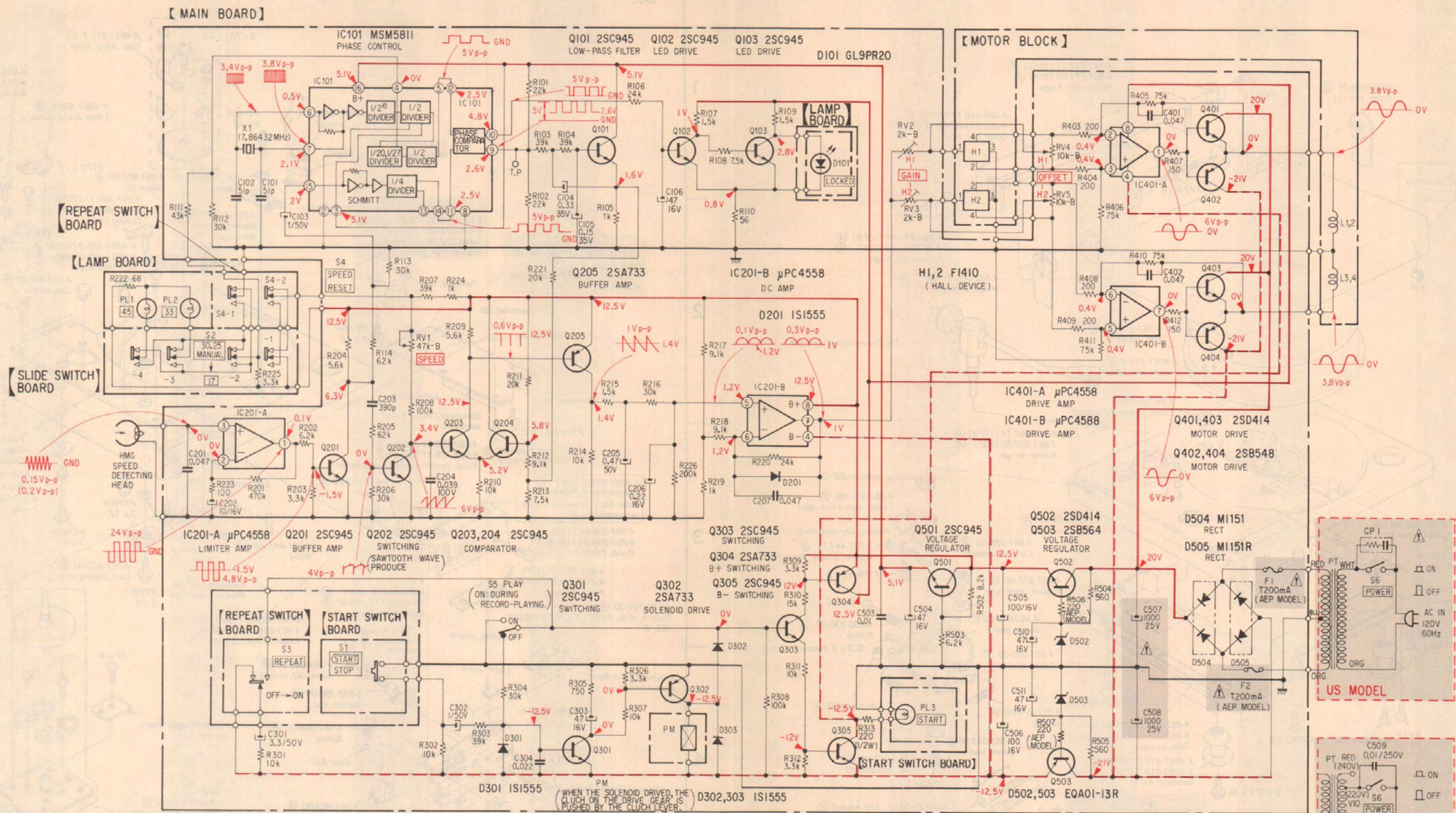

- Note:**
- All capacitors are in μF unless otherwise noted. $\text{pF} = \mu\mu\text{F}$. 50WV or less are not indicated except for electrolytics.
 - All resistors are in ohms, $\frac{1}{2}\text{W}$ unless otherwise noted. $\text{k}\Omega = 1000\Omega$, $\text{M}\Omega = 1000\text{k}\Omega$
 - Waveforms are sketched at 33rpm.
 - — : B+ bus.
 - □ : panel designation.
 - □ : adjustment for repair.
 - - - - : B- bus.
 - Readings are taken at 33 rpm with a VOM (20k Ω /V). () : 45 rpm
 - Voltage variations may be noted due to normal production tolerances.

• Switch

Ref. No.	Switch	Position
S1	START/STOP	OFF
S2	record size/manual selector	30-25-MANUAL
S3	REPEAT	OFF
S4	SPEED RESET	OFF
S5	play	OFF
S6	POWER	OFF

Note: The components identified by shading and mark are critical for safety. Replace only with part number specified.

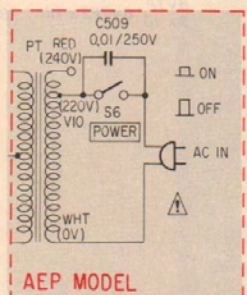
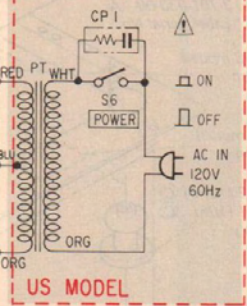
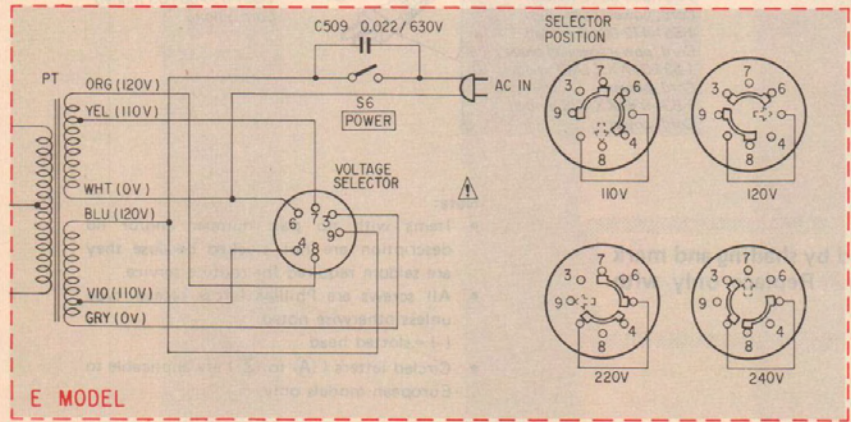

SECTION 5
EXPLODED VIEWS

PS-10F/10FB PS-10F/10FB

A

B

C

D

5-1.

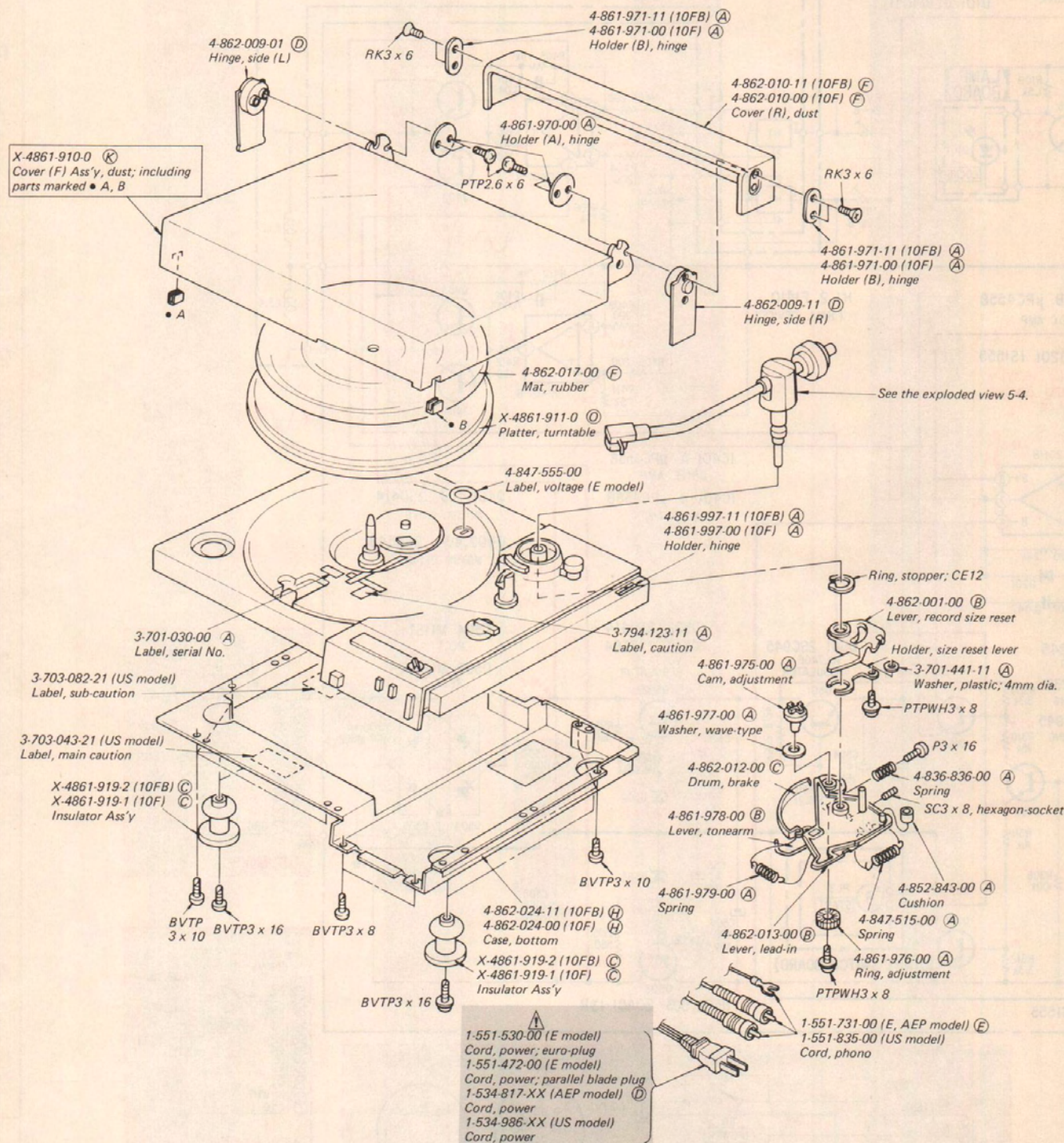

Note: The components identified by shading and mark **A** are critical for safety. Replace only with part number specified.

- Note:
- Items with no part number and/or no description are not stocked because they are seldom required for routine service.
 - All screws are Phillips (cross recess) type unless otherwise noted. (-) = slotted head
 - Circled letters (A to Z) are applicable to European models only.

5-2.

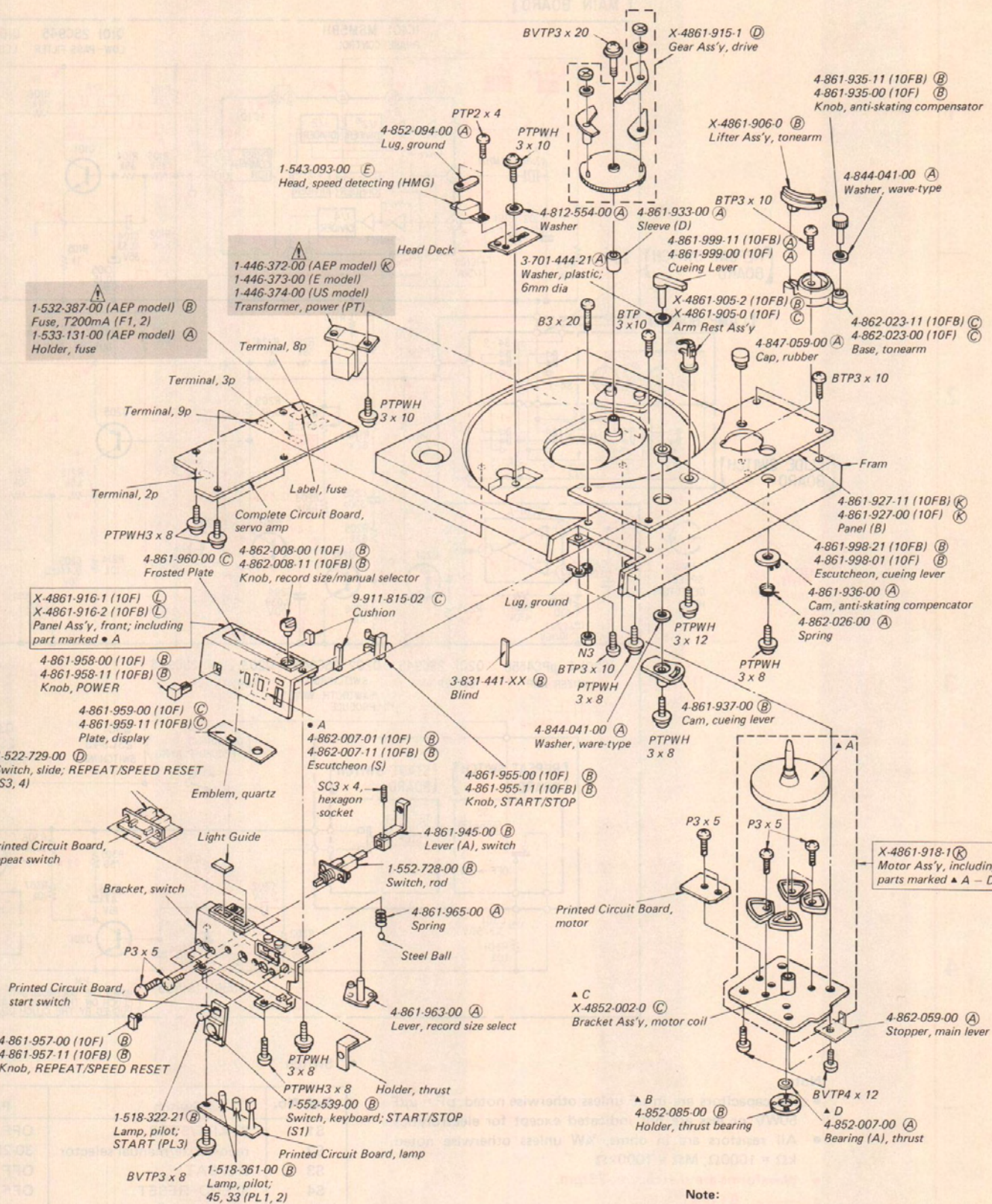

Note: The components identified by shading and mark **A** are critical for safety. Replace only with part number specified.

- Note:
- Items with no part number and/or no description are not stocked because they are seldom required for routine service.
 - All screws are Phillips (cross recess) type unless otherwise noted. (-) = slotted head
 - Circled letters (A to Z) are applicable to European models only.

A

B

C

D

5-3.

1

2

3

4

5

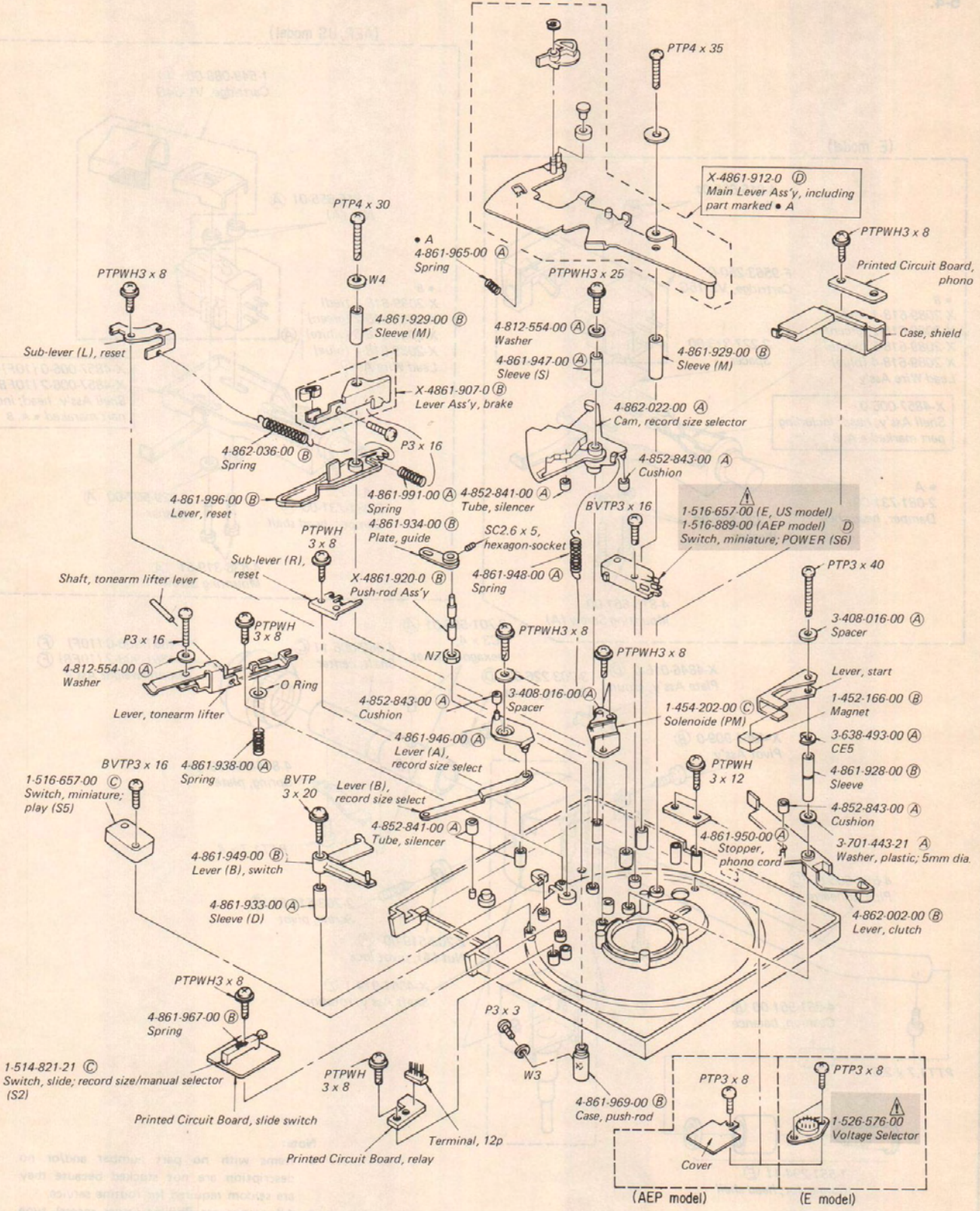

Note: The components identified by shading and mark  are critical for safety. Replace only with part number specified.

- Note:**
- Items with no part number and/or no description are not stocked because they are seldom required for routine service.
 - All screws are Phillips (cross recess) type unless otherwise noted.
(-) = slotted head
 - Circled letters (A to Z) are applicable to European models only.

SECTION 6
ELECTRICAL PARTS LIST

Note: Circled letters (A to Z) are applicable to European models only.

5-4.

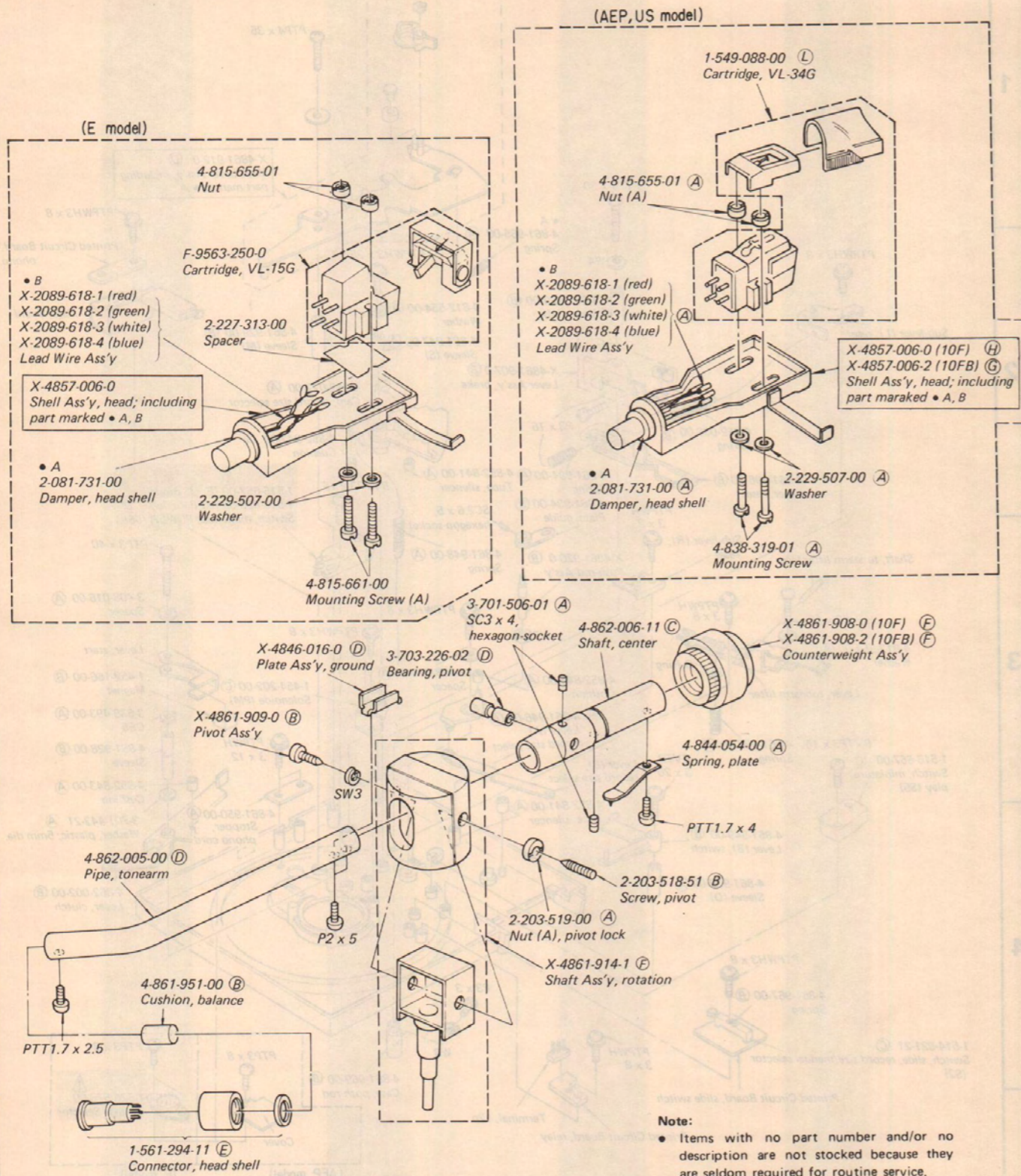

Note:
 • Items with no part number and/or no description are not stocked because they are seldom required for routine service.
 • All screws are Phillips (cross recess) type unless otherwise noted.
 (-) = slotted head
 • Circled letters (A to Z) are applicable to European models only.

Ref. No. Part No. Description

SEMICONDUCTORS

Transistors

⇒ Q101-103	8-729-663-47	(C)	2SC1364
⇒ Q201-204			
⇒ Q205	8-729-612-77	(B)	2SA1027R
⇒ Q301	8-729-663-47	(C)	2SC1364
⇒ Q302	8-729-612-77	(B)	2SA1027R
⇒ Q303	8-729-663-47	(C)	2SC1364
⇒ Q304	8-729-612-77	(B)	2SA1027R
⇒ Q305	8-729-663-47	(C)	2SC1364
Q401	8-729-141-43	(B)	2SD414
Q402	8-729-154-83	(B)	2SB548
Q403	8-729-141-43	(B)	2SD414
Q404	8-729-154-83	(B)	2SB548
⇒ Q501	8-729-663-47	(C)	2SC1364
Q502	8-729-141-43	(B)	2SD414
Q503	8-729-156-43	(B)	2SB564

ICs

IC101	8-759-958-11	(L)	MSM5811
⇒ IC201, 401	8-759-145-58	(D)	μPC4558

Diodes

D101	8-719-900-92	(B)	GL9PR20
D201	8-719-815-55	(B)	1S1555
D301-303			
⇒ D502, 503	8-719-931-13	(B)	EQB01-13
⇒ D504	8-719-500-34	(C)	S3VC40
⇒ D505	8-719-501-34	(C)	S3VC40R

Hall Devices

H1, 2	8-719-841-01	(D)	F1410
-------	--------------	-----	-------

TRANSFORMERS

PT	A	1-446-372-00	(K)	Power (AEP model)
		1-446-373-00		Power (E model)
		1-446-374-00		Power (US model)

⇒: Due to standardization, interchangeable replacements may be substituted for parts specified in the diagrams.

Ref. No. Part No. Description

CAPACITORS

All capacitors are in μF and ceramic unless otherwise noted. 50WV or less are not indicated except for electrolytics. p : μμF, elect : electrolytic

C101, 102	1-102-522-00	(A)	51p	
C103	1-123-352-00	(B)	1	50V elect
C104	1-131-212-00	(B)	0.33	35V tantalum
C105	1-131-210-00	(B)	0.15	35V tantalum
C106	1-123-319-00	(B)	47	16V elect
C201	1-101-006-00	(A)	0.047	
C202	1-123-316-00	(B)	10	16V elect
C203	1-102-113-00	(A)	390p	
C204	1-130-140-00	(B)	0.039	100V film
C205	1-123-351-00	(B)	0.47	50V elect
C206	1-131-418-00	(B)	0.22	16V tantalum
C207	1-101-006-00	(A)	0.047	
C301	1-123-354-00	(B)	3.3	50V elect
C302	1-123-352-00	(B)	1	50V elect
C303	1-123-319-00	(B)	47	16V elect
C304	1-101-005-00	(A)	0.022	
C401, 402	1-101-006-00	(A)	0.047	
C503	1-101-004-00	(A)	0.01	
C504	1-123-319-00	(B)	47	16V elect
C505, 506	1-123-320-00	(B)	100	16V elect
C507, 508	1-123-337-00	(B)	1000	25V elect
C509	A	1-129-718-00	0.022	630V polyethylene (E model)
	A	1-130-196-00	D	0.01 250V polyethylene (AEP model)
C510, 511	1-123-319-00	(B)	47	16V elect

RESISTORS

All resistors are in ohms. Common 1/4W carbon resistors are omitted. Check schematic diagram for values.

R207	1-214-170-00	(A)	39k	1/4W	metal oxide
R313	1-244-857-00	(A)	220	1/2W	carbon

Note: The components identified by shading and mark A are critical for safety. Replace only with part number specified.

Note: Circled letters (A) to (Z) are applicable to European models only.

Ref. No.	Part No.	Description
RV1	1-224-254-XX	(B) 47k-B, adjustable; speed
RV2, 3	1-226-234-00	(A) 2k-B, adjustable; gain
RV4, 5	1-226-236-00	(A) 10k-B, adjustable; offset

SWITCHES

S1	1-552-539-00	(B) Keyboard, START/STOP
S2	1-514-821-21	(C) Slide, record size/manual selector
S3, 4	1-552-729-00	(D) Slide, REPEAT/SPEED RESET
S5	1-516-657-00	(C) Miniature, play
S6	(A) 1-516-657-00	Miniature, POWER (US, E model)
	1-516-889-00	(D) Miniature, POWER (AEP model)

MISCELLANEOUS

CPI	(A) 1-231-326-11	Encapsulated Component (US model)
F1, 2	(A) 1-532-387-00	(B) Fuse, T200mA (AEP model)
HMG	1-543-093-00	(E) Head, speed detecting
PL1, 2	1-518-361-00	(B) Lamp, pilot; 45/33
PL3	1-518-322-21	(B) Lamp, pilot; START
PM	1-454-202-00	(C) Solenoid
X1	1-527-348-00	(D) Crystal
	1-452-166-00	(B) Magnet
	(A) 1-526-576-00	Voltage Selector (E model)
	(A) 1-533-131-00	(A) Fuse Holder (AEP model)
	(A) 1-534-817-XX	(D) Cord, power (AEP model)
	(A) 1-534-986-XX	Cord, power (US model)
	1-549-088-00	(L) Cartridge, VL-34G (US, AEP model)
	(A) 1-551-472-00	Cord, power; parallel-blade plug (E model)
	(A) 1-551-530-00	Cord, power; euro-plug (E model)
	1-551-731-00	(E) Cord, phono (AEP, E model)
	1-551-835-00	Cord, phono (US model)
	1-552-728-00	(B) Rod, switch
	1-561-294-11	(E) Connector, head shell
	F-9563-250-0	Cartridge, VL-15G (E model)
	X-2089-618-1	(A) Lead Wire Ass'y (red)
	X-2089-618-2	(A) Lead Wire Ass'y (green)
	X-2089-618-3	(A) Lead Wire Ass'y (white)
	X-2089-618-4	(A) Lead Wire Ass'y (blue)
	X-4861-918-1	(K) Motor Ass'y

ACCESSORIES AND PACKING MATERIALS

Part No.	Description
1-501-184-00	(C) Antenna, ribbon
3-701-613-00	(A) Bag, plastic
3-701-616-00	(A) Bag, plastic
3-701-630-00	(A) Bag, plastic
3-701-634-00	(A) Bag, plastic
3-701-806-00	(A) Adaptor, 45rpm
3-770-683-11	(I) Manual, instruction; GG-10F/10FB (AEP model)
3-770-683-21	Manual, instruction; GG-10F (US model)
3-770-683-51	Manual, instruction; GG-10F (E model)
3-793-395-11	(B) Gauge, tracking error check
4-858-292-00	(C) Bag, plastic
4-858-407-00	(B) Key, drop-point adjustment
4-861-904-00	(B) Holder, turntable platter
4-861-905-00	(A) Sheet, protection
4-861-906-00	(B) Cushion, upper
4-861-907-00	(B) Cushion, left
4-861-908-00	(B) Cushion, right
4-862-029-00	(B) Cushion, dust cover
4-862-039-00	(B) Holder, dust cover
4-862-040-00	(B) Sheet, protection
4-862-044-00	(A) Spacer, drive gear
4-862-060-00	(B) Cushion, tonearm

Note: The components identified by shading and mark (A) are critical for safety. Replace only with part number specified.